

Session 2: Solid State Physics

# Crystal

# Outline

1. Introduction	□□□□□□□□
2. Crystal	□□□□□□□□□□
3. Cubic Lattices	□□□□□□□□
4. Other	□□□□
5. Miller Indices	□□□□□

- ◎ Introduction
  - Course information
  - Technology
  - State of matter
  - Micro/macro -oscopic aspects of matter
- ◎ Crystal
  - Bravis lattice
  - Primitive unit cell, unit vectors, Wigner-Seitz unit cell
  - Basis, Crystal
  - Example: Graphene
- ◎ Cubic Lattices
  - SC, BCC, FCC, Zinc Blende
- ◎ Other
- ◎ Symmetry
- ◎ Miller Indices

# Introduction – Text Books

1. Introduction	□□□□□□□□
2. Crystal	□□□□□□□□□□
3. Cubic Lattices	□□□□□□□
4. Other	□□□□
5. Miller Indices	□□□□□

Streetman,  
Solid State Electronic  
Devices

Pierret,  
Semiconductor Device  
Fundamentals

Yang,  
Microelectronic Devices

Muller,  
Device Electronics for  
Integrated Circuits

# Introduction – Course Information

1. Introduction	<input type="checkbox"/>	<input type="checkbox"/>	<input type="checkbox"/>	<input type="checkbox"/>	<input type="checkbox"/>	<input type="checkbox"/>	<input type="checkbox"/>	<input type="checkbox"/>	<input type="checkbox"/>
2. Crystal	<input type="checkbox"/>	<input type="checkbox"/>	<input type="checkbox"/>	<input type="checkbox"/>	<input type="checkbox"/>	<input type="checkbox"/>	<input type="checkbox"/>	<input type="checkbox"/>	<input type="checkbox"/>
3. Cubic Lattices	<input type="checkbox"/>	<input type="checkbox"/>	<input type="checkbox"/>	<input type="checkbox"/>	<input type="checkbox"/>	<input type="checkbox"/>	<input type="checkbox"/>	<input type="checkbox"/>	<input type="checkbox"/>
4. Other	<input type="checkbox"/>	<input type="checkbox"/>	<input type="checkbox"/>	<input type="checkbox"/>	<input type="checkbox"/>	<input type="checkbox"/>	<input type="checkbox"/>	<input type="checkbox"/>	<input type="checkbox"/>
5. Miller Indices	<input type="checkbox"/>	<input type="checkbox"/>	<input type="checkbox"/>	<input type="checkbox"/>	<input type="checkbox"/>	<input type="checkbox"/>	<input type="checkbox"/>	<input type="checkbox"/>	<input type="checkbox"/>

Course homepage:

<http://ee.sharif.edu/~sarvari/Teaching.html>

*Refresh the page!*

Grading (tentative):

2-MidTerms (40%) + HW & Quizzes (20%) + Final (40%)

?, ?

<http://cw.sharif.edu/>

# Technology Challenges

1. Introduction	▢▢▢▢▢▢▢▢
2. Crystal	▢▢▢▢▢▢▢▢▢▢▢▢
3. Cubic Lattices	▢▢▢▢▢▢▢▢
4. Other	▢▢▢▢
5. Miller Indices	▢▢▢▢▢

S curve

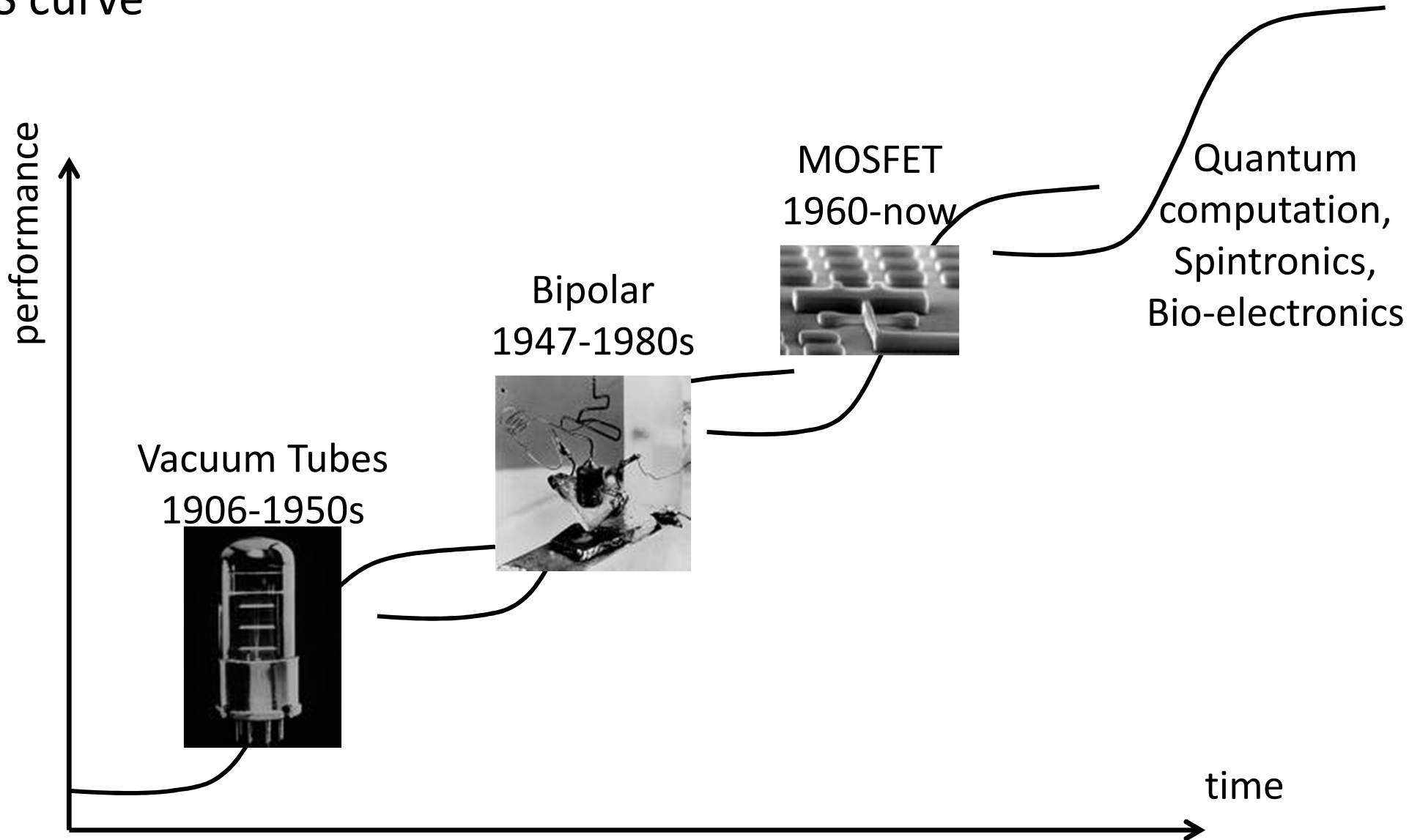

# Abbreviated Periodic Table

1. Introduction	▣▣▣▣▣▣▣▣
2. Crystal	▣▣▣▣▣▣▣▣▣▣▣▣▣▣
3. Cubic Lattices	▣▣▣▣▣▣▣▣
4. Other	▣▣▣▣
5. Miller Indices	▣▣▣▣

Elements:

Si, Ge, C

Binary:

III-V: GaAs, InP

II-VI: ZnSe (zinc selenide), CdTe (cadmium telluride)

IV-IV: SiC

IV-VI: PbS (lead sulphide)

Alloys:

ternary:  $Al_{1-x}Ga_{1-x}As$ ,  $Hg_{1-x}Cd_xTe$

Quaternary:  $In_{1-x-y}Ga_xAl_yAs$ ,  $In_{1-x}Ga_xAs_{1-y}P_y$

II	III	IV	V	VI
4 Be	5 B	6 C	7 N	8 O
12 Mg	13 Al	14 Si	15 P	16 S
30 Zn	31 Ga	32 Ge	33 As	34 Se
48 Cd	49 In	50 Sn	51 Sb	52 Te
80 Hg	81 Tl	82 Pb	83 Bi	84 Po

Not all combinations possible:

lattice mismatch, room temp. instability, etc. are concerns

## ? Why Solid State?

1. Solid: density  $\sim 10^{22} / \text{cm}^3$

1. a: Crystal: long range order (lattice + basis) {Ex: Epitaxial silicon and diamond}

1. b: Polycrystal: short range order ( $\mu\text{m} \sim 10\mu\text{m}$ ) {Ex: Most metals (Al, Cu) Ploy-Si}

1. c: Amorphous: no order {Example: Glasses like  $\text{SiO}_2$ }

2. Liquids: no order, takes the shape of the container, weak bounds; density  $\sim 10^{19} / \text{cm}^3$

3. Gases: no order, no bounds between molecules

4. Liquid crystals: atoms mobile, type of long range order  
Applications: LCDs

5. Plasma: Ionized gas/liquid {Ex: Sun, Aurora, Lightning, (RIE, Sputtering, PECVD)}

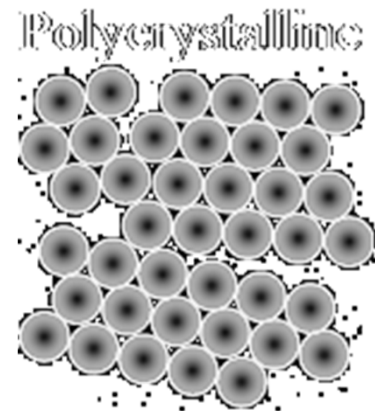
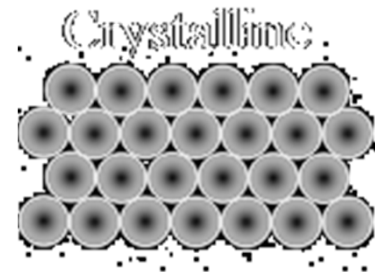

# Why WE Should care?

1. Introduction	□□□□□□□□
2. Crystal	□□□□□□□□□□
3. Cubic Lattices	□□□□□□□□
4. Other	□□□□
5. Miller Indices	□□□□□

Isn't it for physics / Chemistry / Material Science Department?

1. Solid: density  $\sim 10^{22} / \text{cm}^3$ 
  - a: Crystal: long range order (lattice + basis)  
{Example: Epitaxial silicon and diamond}
  - b: Polycrystalline: short range order ( $\mu\text{m} \sim 10\mu\text{m}$ )  
{Example: Most metals (Al, Cu) Ploy-Si}
  - c: Amorphous: no order  
{Example: Glasses like  $\text{SiO}_2$ }

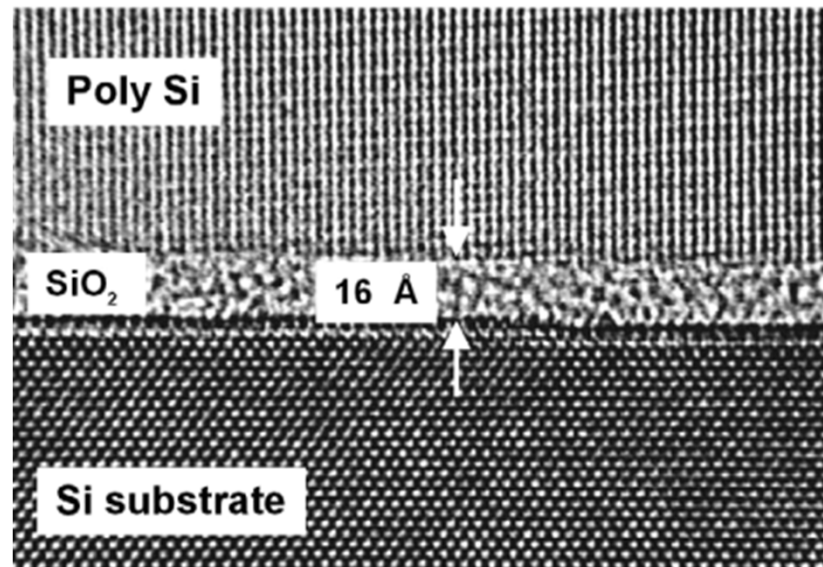



# Resistivity

1. Introduction	□□□□□□□□
2. Crystal	□□□□□□□□□□
3. Cubic Lattices	□□□□□□□
4. Other	□□□□
5. Miller Indices	□□□□□

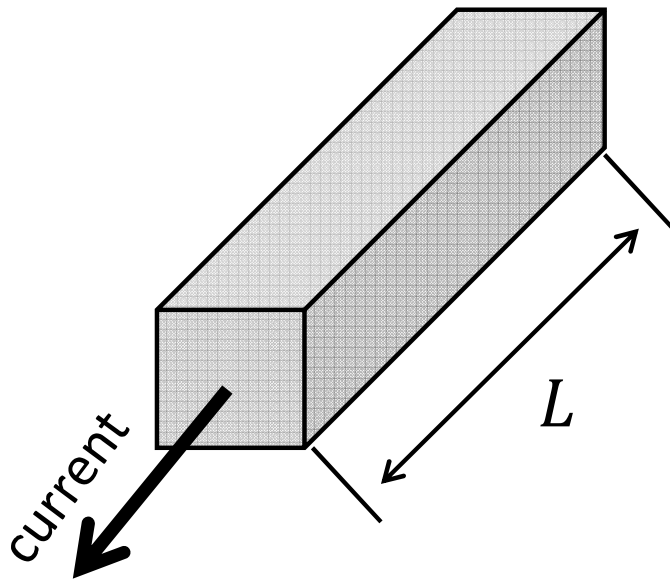

Ohm's law

$$R = \frac{V}{I} \rightarrow \rho = R \frac{A}{L} \quad \text{resistivity}$$

Resistivity is characteristic of the material

Art of VLSI design is:  
to put together materials with different resistivity's next to each other to perform a certain task.



# Semiconductors

1. Introduction	□□□□□□□□
2. Crystal	□□□□□□□□□□
3. Cubic Lattices	□□□□□□□
4. Other	□□□□
5. Miller Indices	□□□□□

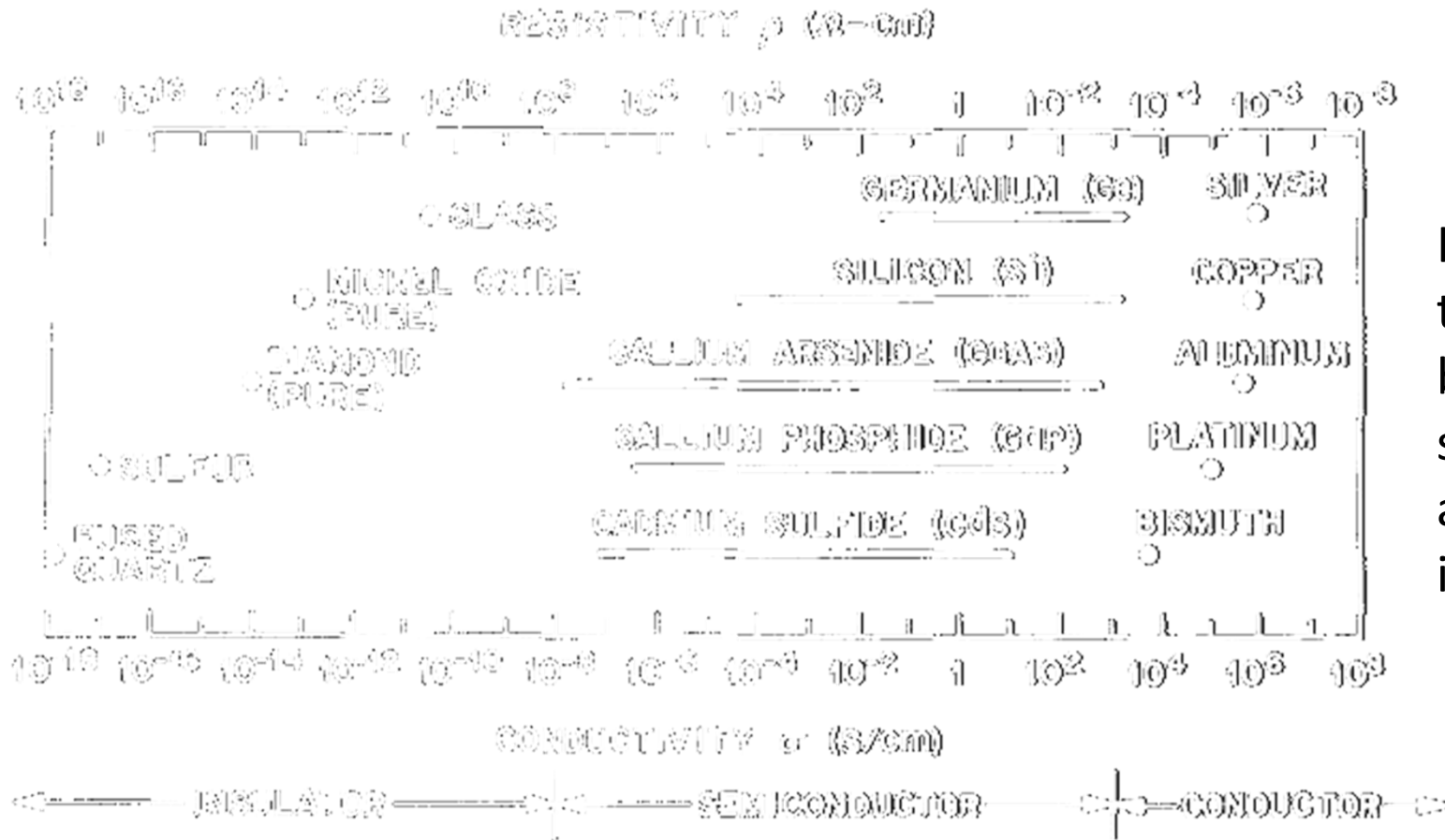

?

Is the “resistivity” the only difference between semiconductors and conductor / insulators ?

In semiconductors: conductivity is controllable

In conductors: carriers are “electrons”

In semiconductors: carriers are “electrons” + “holes”

# A Little History – Crystal Structure

1. Introduction	□□□□□□□□
2. Crystal	□□□□□□□□□□
3. Cubic Lattices	□□□□□□
4. Other	□□□□
5. Miller Indices	□□□□

Solids tend to form ordered crystals

Rock Salt



Rock Candy



Mineralogists have been familiar with crystal structures since 18th century.  
1912: Diffraction of x-rays by a periodic array.  
Today : Condensed matter physics long way to go .....

Properties (mechanical, electrical, optical and thermal properties all affected) of solids depends on their structure

# Crystal Lattice

1. Introduction	□□□□□□□□
2. Crystal	□□□□□□□□□□
3. Cubic Lattices	□□□□□□
4. Other	□□□□
5. Miller Indices	□□□□

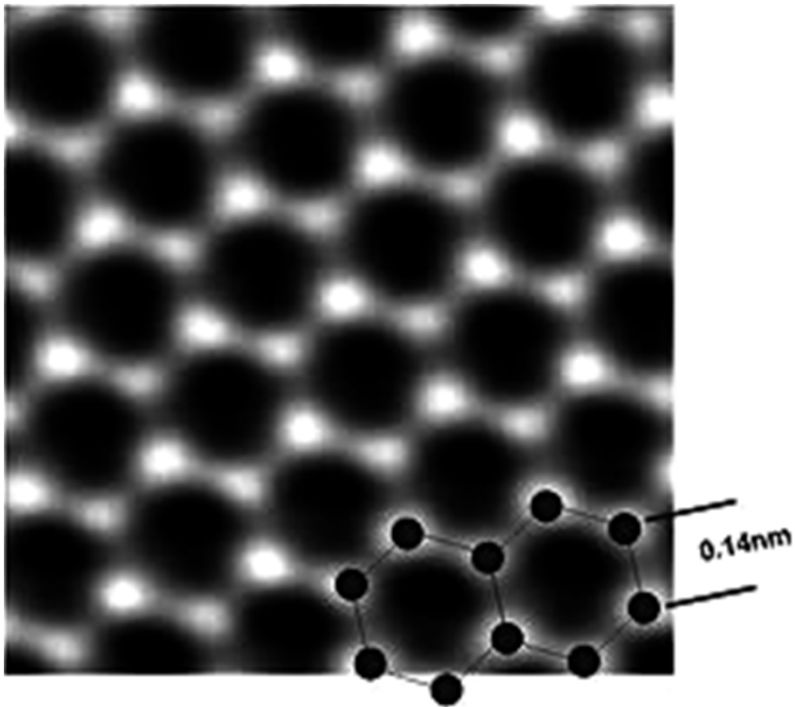
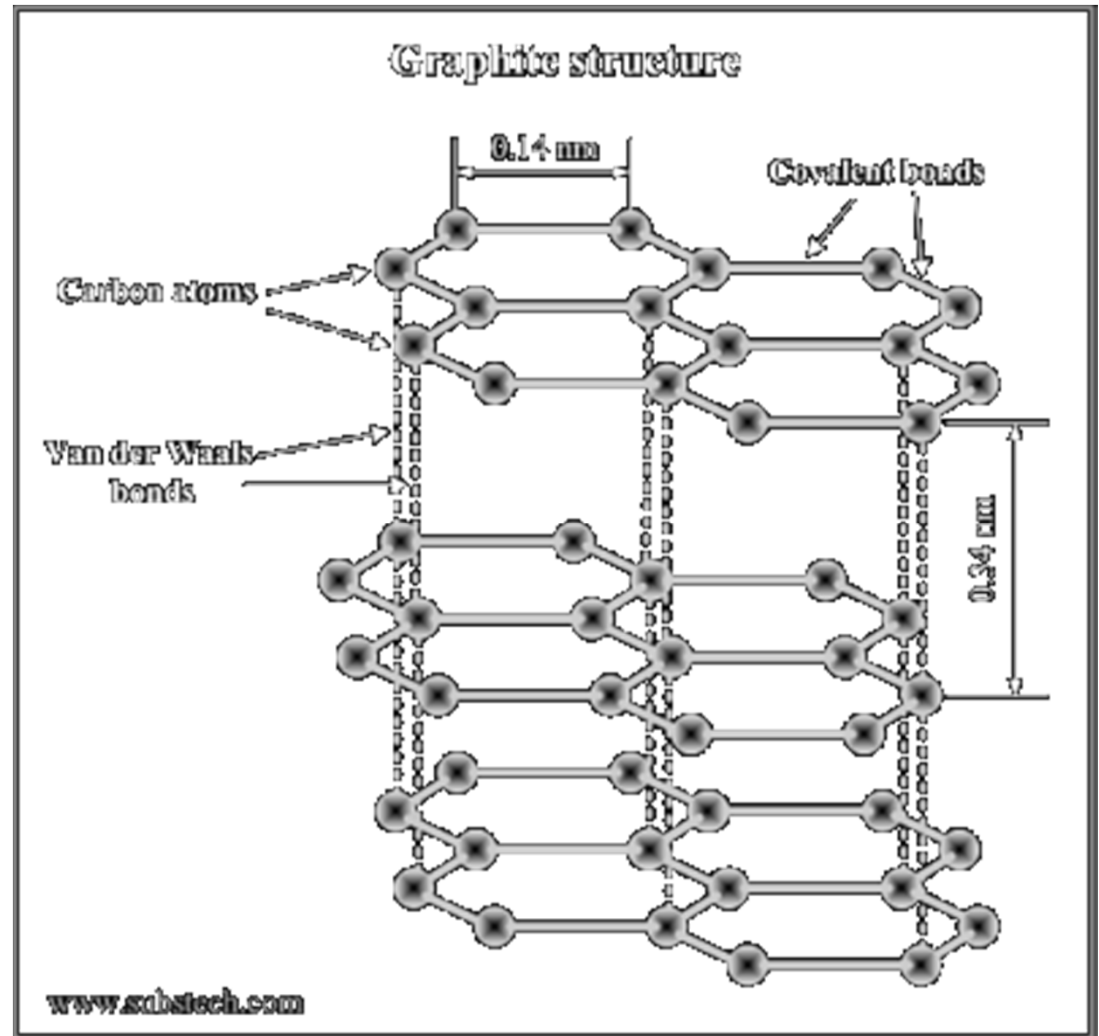

Image of graphene in a transmission electron microscope.



# Bravais Lattice

1. Introduction	□□□□□□□□
2. Crystal	□□□□□□□□□□
3. Cubic Lattices	□□□□□□
4. Other	□□□□
5. Miller Indices	□□□□

Ideal Crystal: Infinite repetition of identical structural units in space.

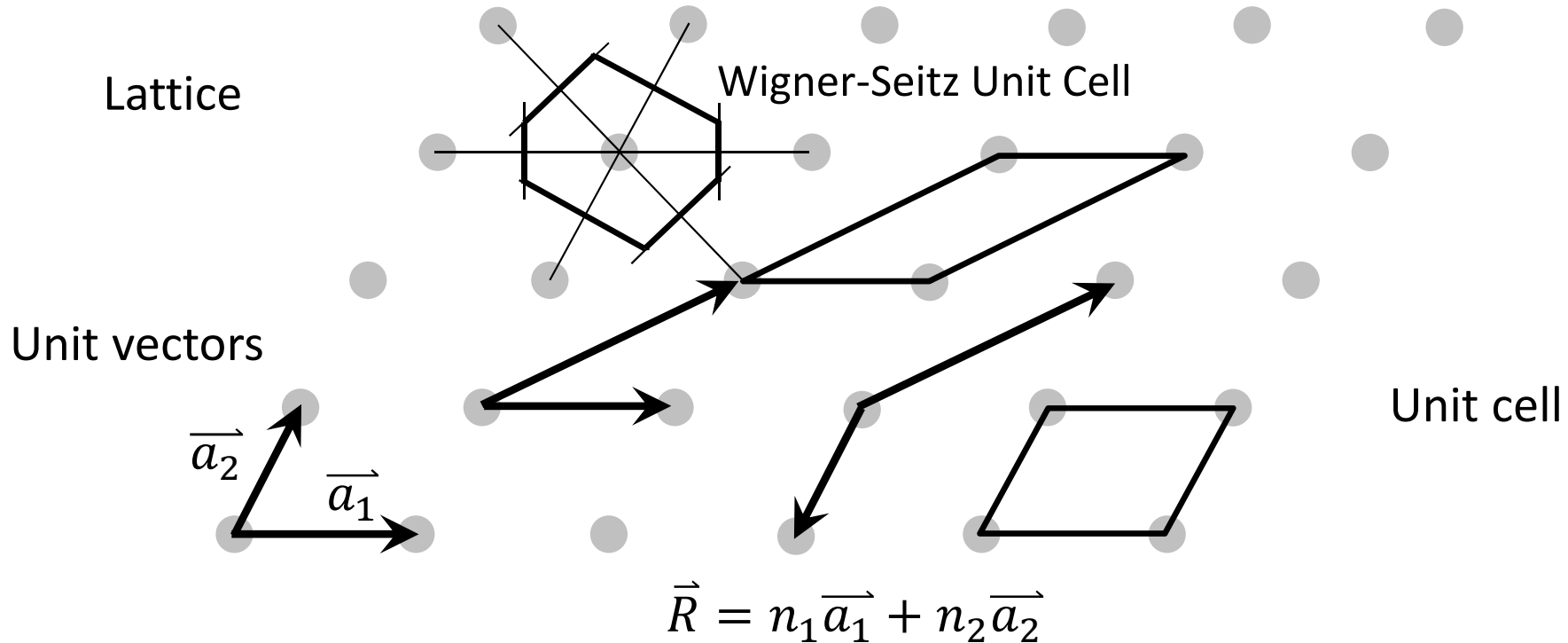

Bravais lattice: is the set of points defined by  $\vec{R} = n_1\vec{a}_1 + n_2\vec{a}_2$  as  $n_i$  is integer. Shortest possible  $\vec{a}_1$  gives us primitive vectors. The volume cell enclosed by the primitive vectors is called the primitive unit cell.



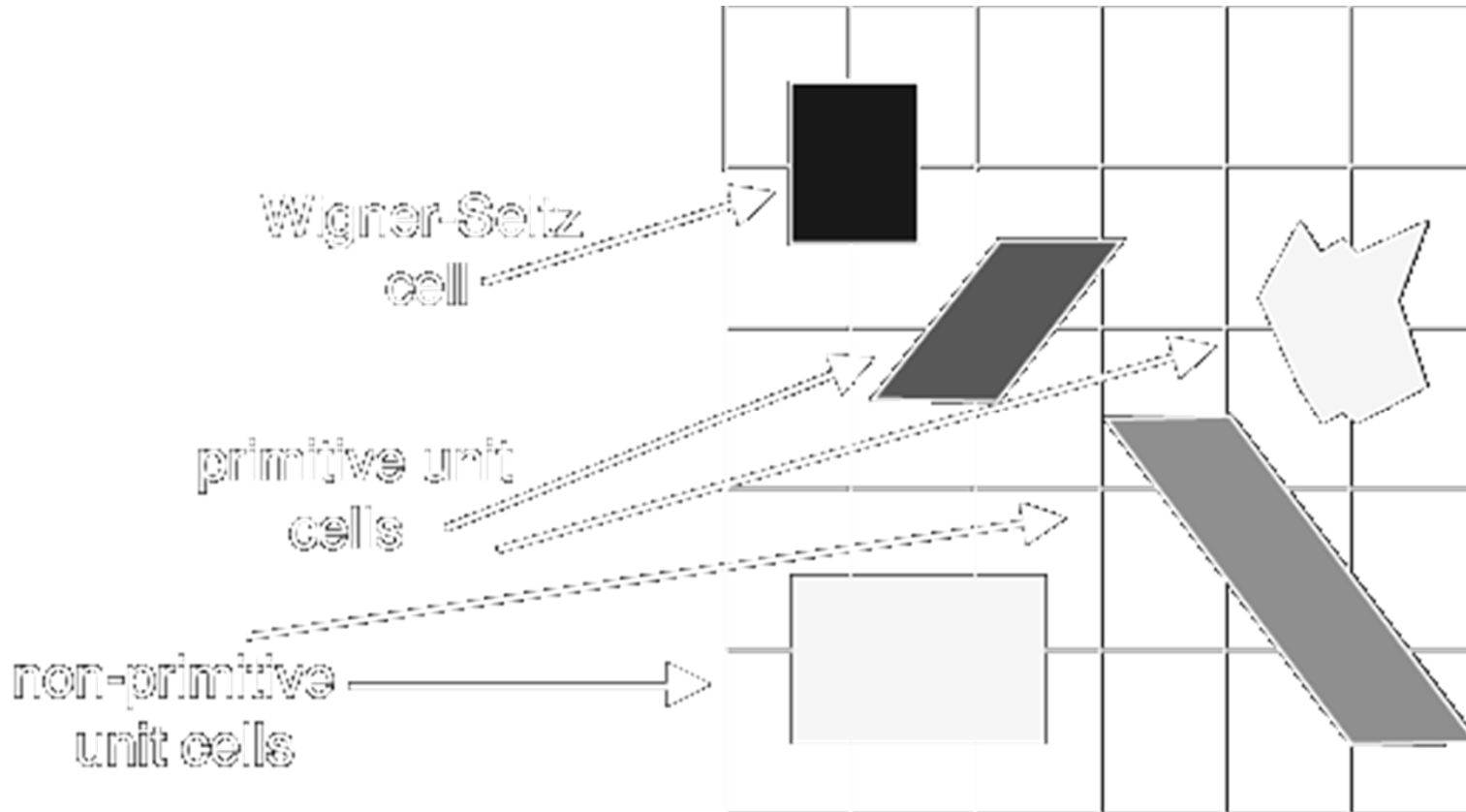

Crystal structure = Lattice + Basis

# Unit cells / Wigner-Seitz cell for a rectangular 2-D lattice

1. Introduction	□□□□□□□□
2. Crystal	□□□□□□□□□□
3. Cubic Lattices	□□□□□□
4. Other	□□□□
5. Miller Indices	□□□□

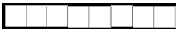

# 1-D Lattices

1. Introduction	
2. Crystal	
3. Cubic Lattices	
4. Other	
5. Miller Indices	

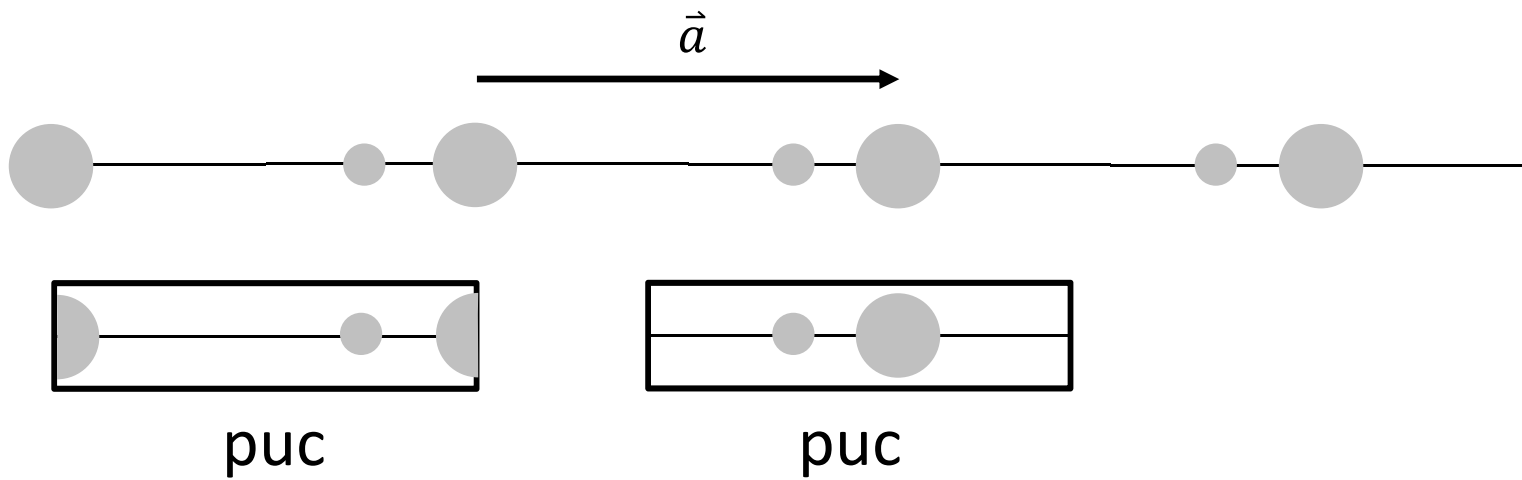
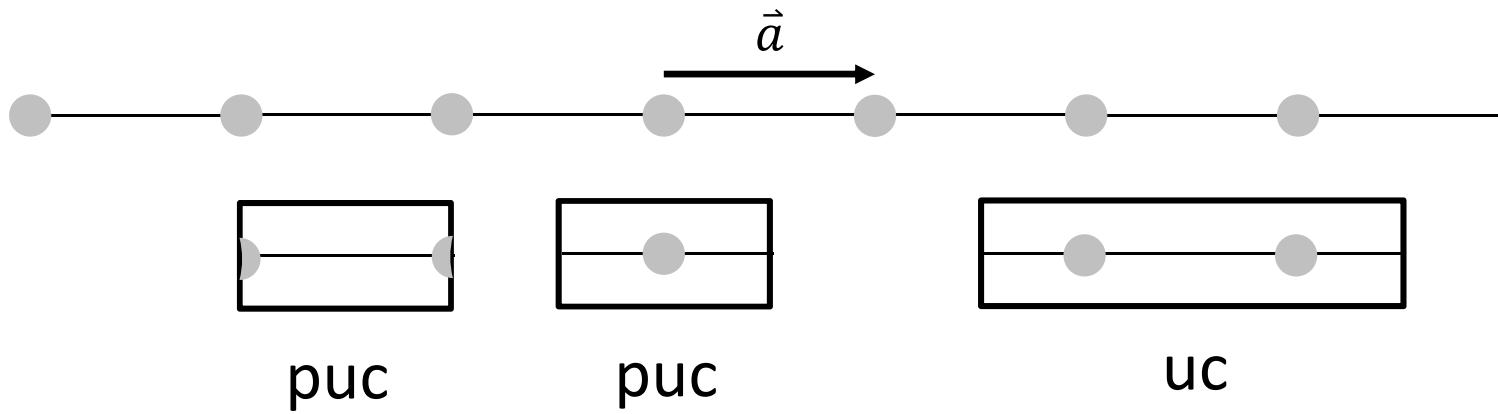

# Crystal structure = Lattice + Basis

1. Introduction	□□□□□□□□
2. Crystal	□□□□□□□□□□
3. Cubic Lattices	□□□□□□□□
4. Other	□□□□
5. Miller Indices	□□□□□

Ideal Crystal: Infinite repetition of identical structural units in space.

Lattice

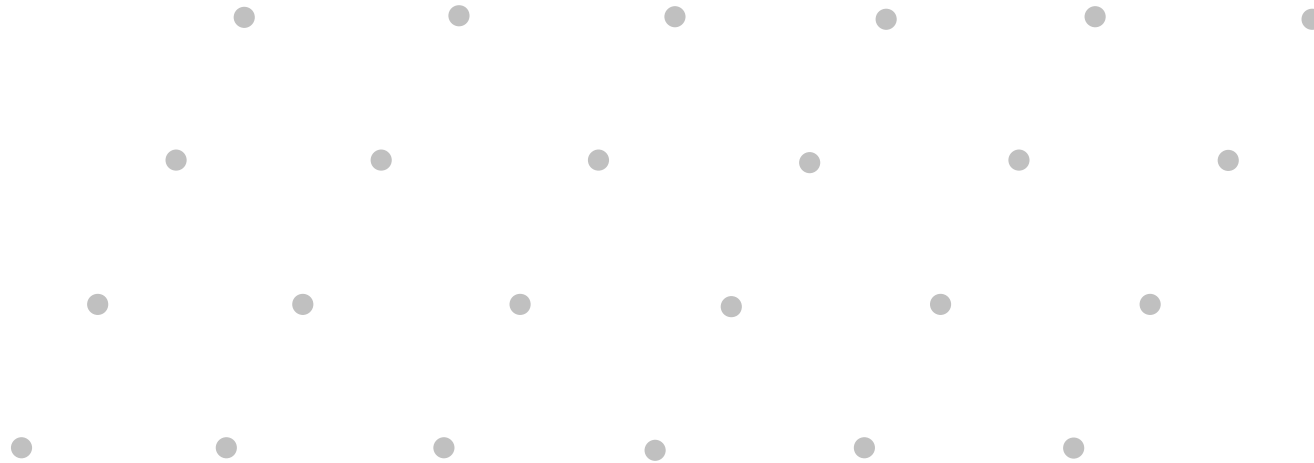

basis



The basis consists of the simplest arrangement of atoms which is repeated at every point in the lattice to build up the crystal structure

Crystal structure = Lattice + Basis



# Crystal structure = Lattice + Basis

1. Introduction	□□□□□□□□
2. Crystal	□□□□□□□□□□
3. Cubic Lattices	□□□□□□□□
4. Other	□□□□
5. Miller Indices	□□□□□

Ideal Crystal: Infinite repetition of identical structural units in space.

Lattice

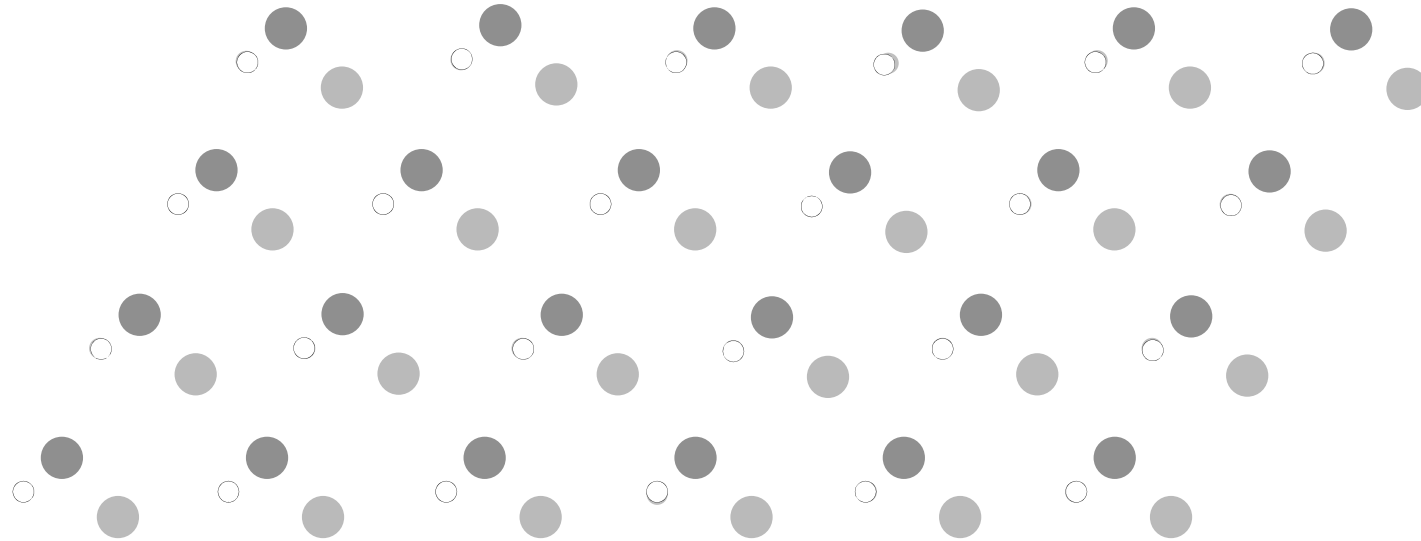

basis



crystal

Crystal structure = Lattice + Basis

# Bravais Lattices in 2D

1. Introduction	□□□□□□□□
2. Crystal	□□□□□□□□□□
3. Cubic Lattices	□□□□□□
4. Other	□□□□
5. Miller Indices	□□□□□

There are only 5 Bravais lattices in 2D

Oblique

1

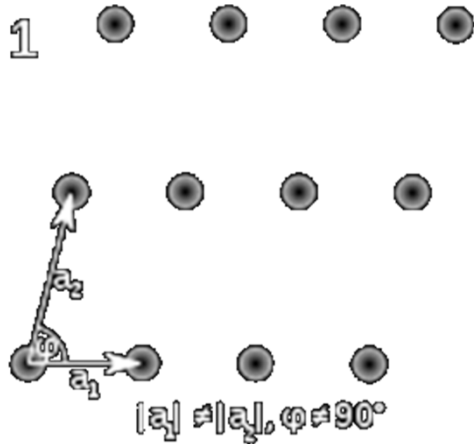

Rectangular

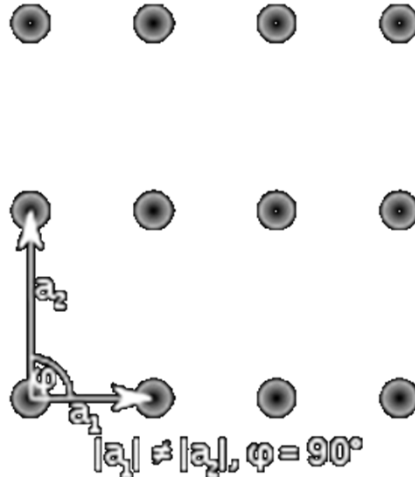

Centered Rectangular

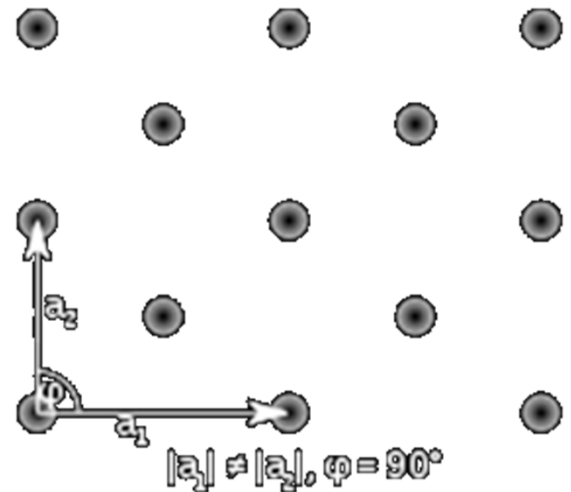

Hexagonal

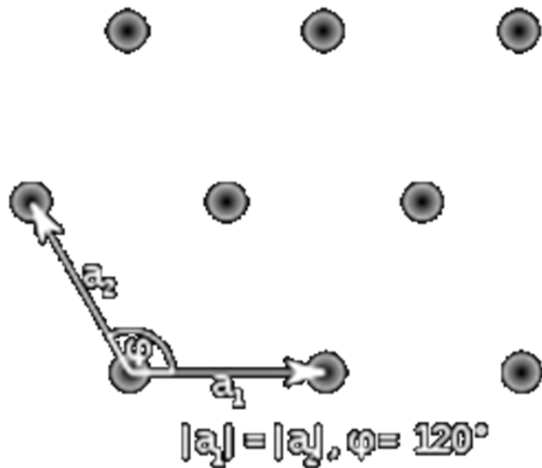

Square

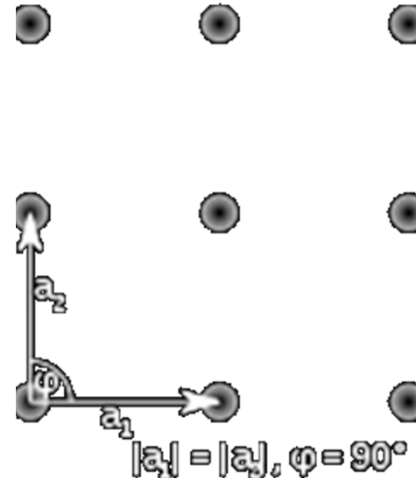

# Crystal Lattice, Graphene



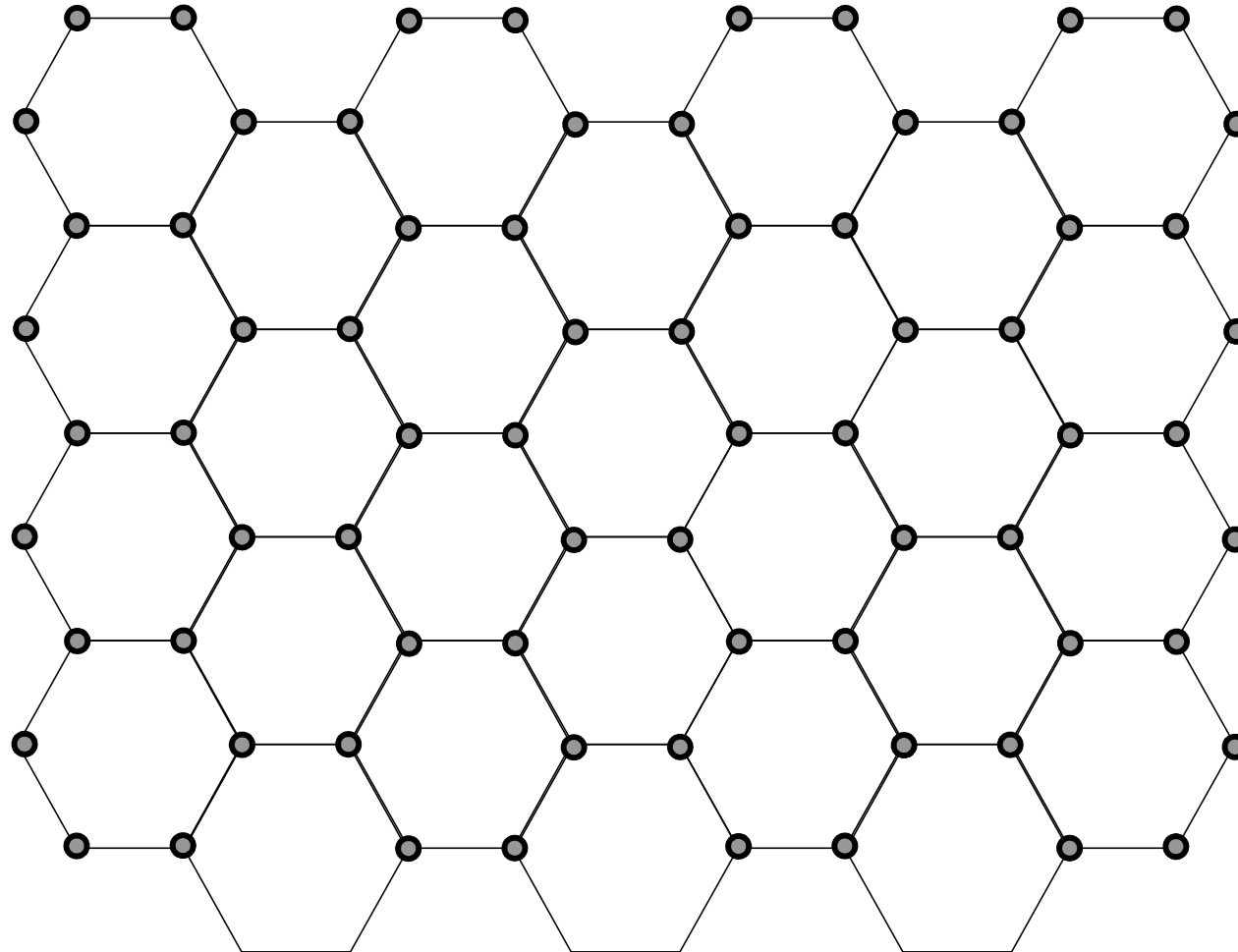

1. Introduction	□□□□□□□□
2. Crystal	□□□□□□□□□□
3. Cubic Lattices	□□□□□□
4. Other	□□□□
5. Miller Indices	□□□□

Example: Graphene

Honeycomb structure

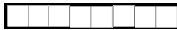

# Crystal Lattice, Graphene

1. Introduction	
2. Crystal	
3. Cubic Lattices	
4. Other	
5. Miller Indices	

Example: Graphene

Honeycomb structure

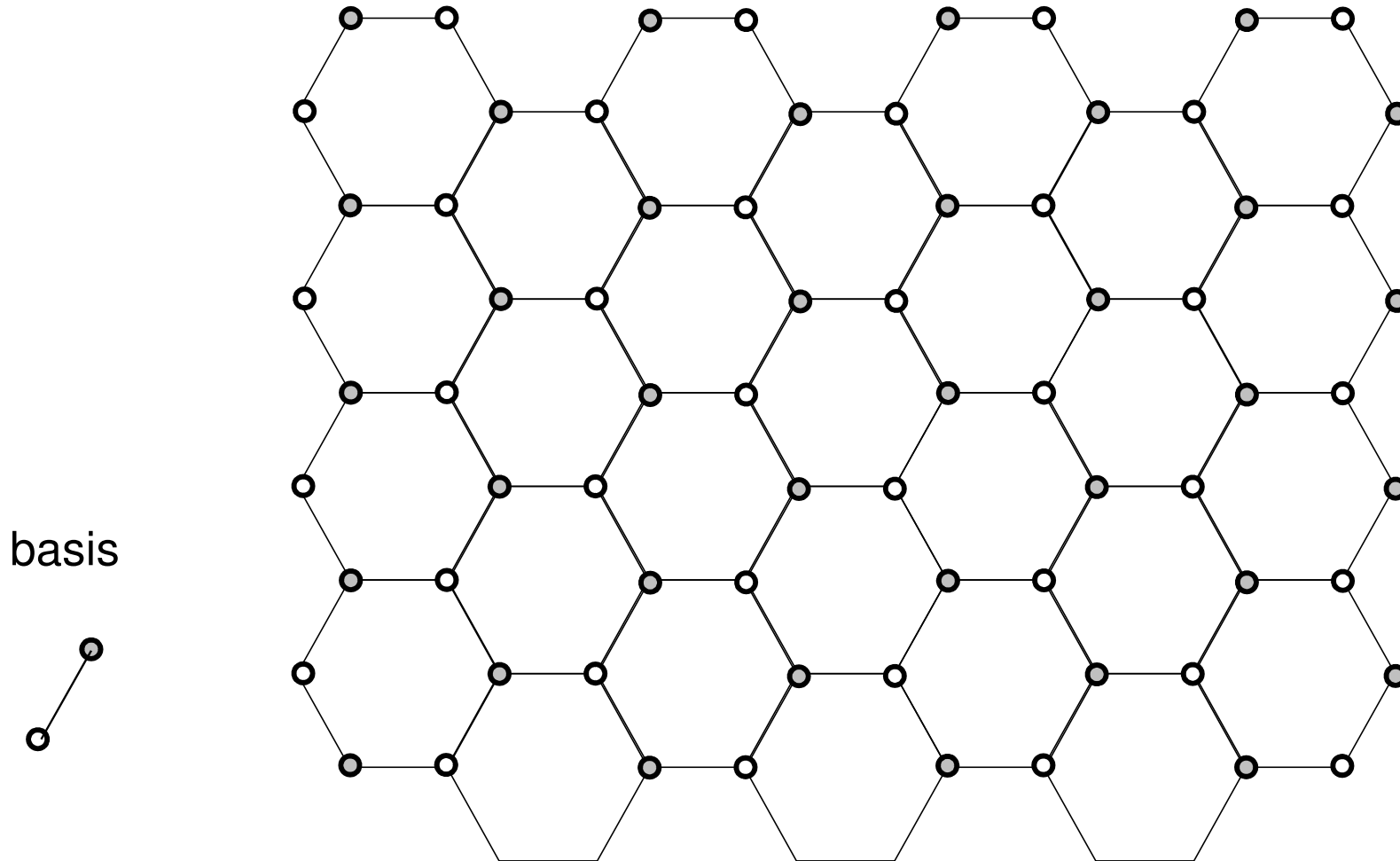

# Crystal Lattice, Graphene

1. Introduction	□□□□□□□□
2. Crystal	□□□□□□□□□□
3. Cubic Lattices	□□□□□□
4. Other	□□□□
5. Miller Indices	□□□□

Example: Graphene

Honeycomb structure

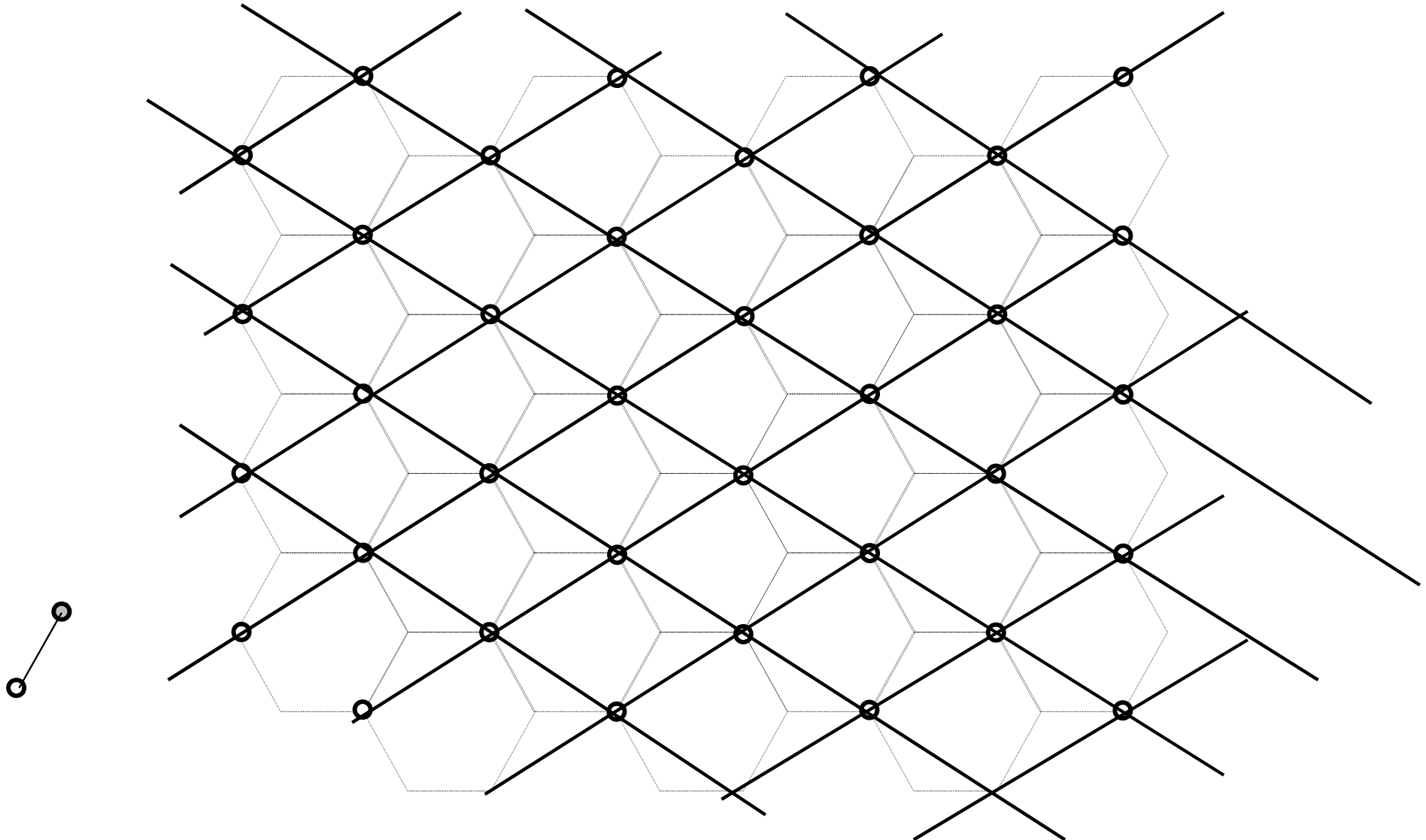

# Crystal Lattice, Graphene

1. Introduction	□□□□□□□□
2. Crystal	□□□□□□□□□□
3. Cubic Lattices	□□□□□□
4. Other	□□□□
5. Miller Indices	□□□□





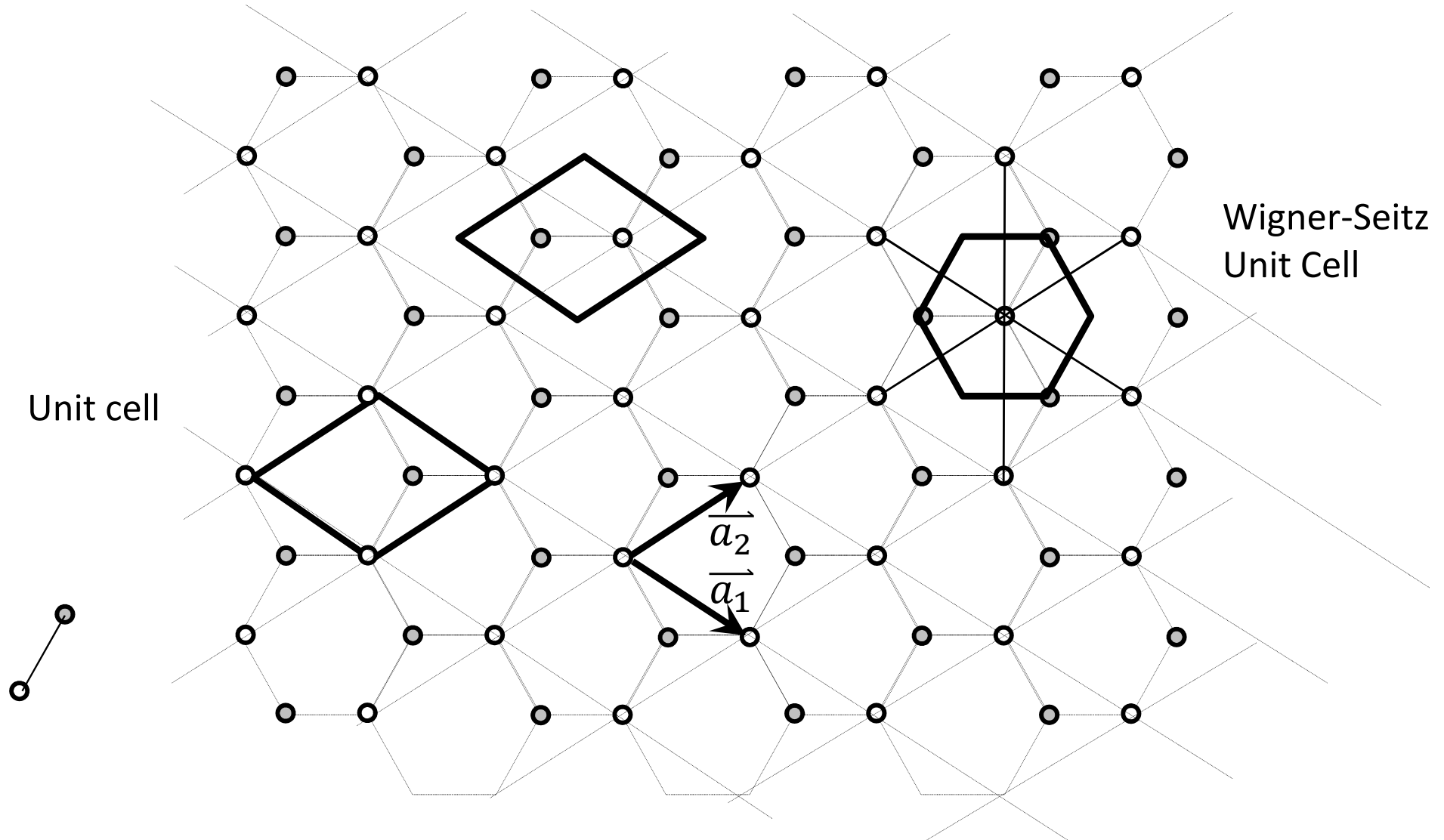







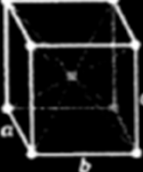

Example: Graphene

Honeycomb structure

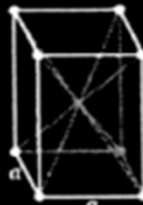

# Bravais Lattices in 3D

There are 14 Bravais lattices in 3D

The 7 lattice systems	The 14 Bravais Lattices			
Triclinic (parallelepiped)	$\alpha, \beta, \gamma \neq 90^\circ$ 			
monoclinic (right prism with parallelogram base; here seen from above)	Simple $\alpha \neq 90^\circ$ $\beta, \gamma = 90^\circ$ 	Centered $\alpha \neq 90^\circ$ $\beta, \gamma = 90^\circ$ 		
orthorhombic (cuboid)	Simple $a \neq b \neq c$ 	base-centered $a \neq b \neq c$ 	body-centered $a \neq b \neq c$ 	face-centered $a \neq b \neq c$ 
tetragonal (square cuboid)	Simple $a \neq c$ 	body-centered $a \neq c$ 		
Rhombohedral (trigonal trapezohedron)	$\alpha = \beta = \gamma \neq 90^\circ$ 			
hexagonal (centered regular hexagon)				
Cubic (isometric; cube)	Simple 	body-centered 	face-centered 	

# Cubic Lattices

1. Introduction	□□□□□□□□
2. Crystal	□□□□□□□□□□
3. Cubic Lattices	□□□□□□□
4. Other	□□□□
5. Miller Indices	□□□□□

Simple cubic (SC)

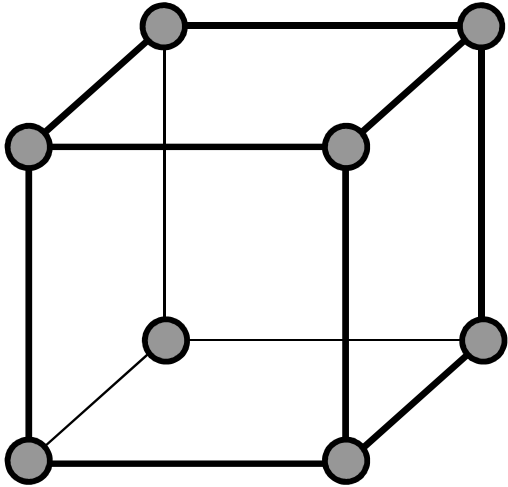

Body-centered cubic (BCC)

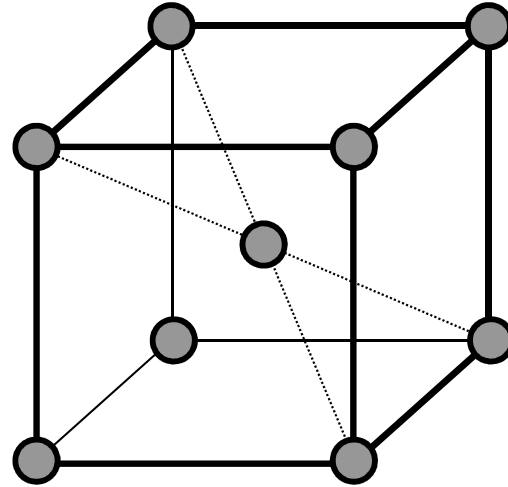

Face centered cubic (FCC)

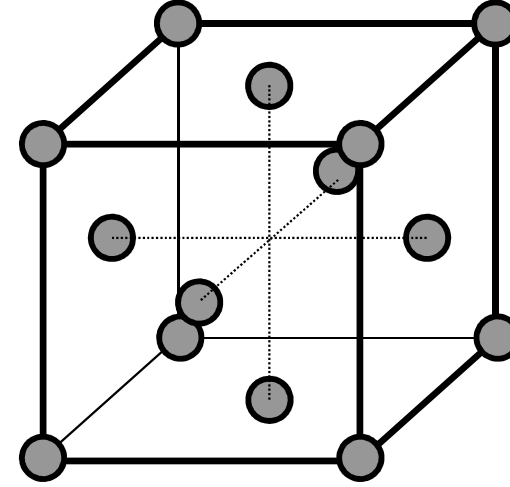

Diamond Lattice

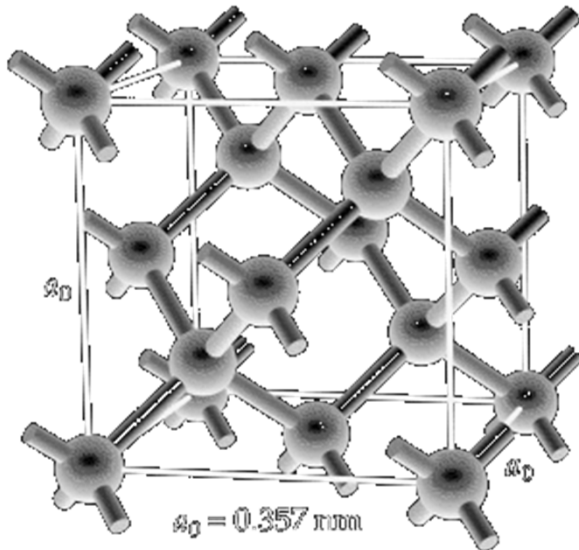

Zinc Blende Structure

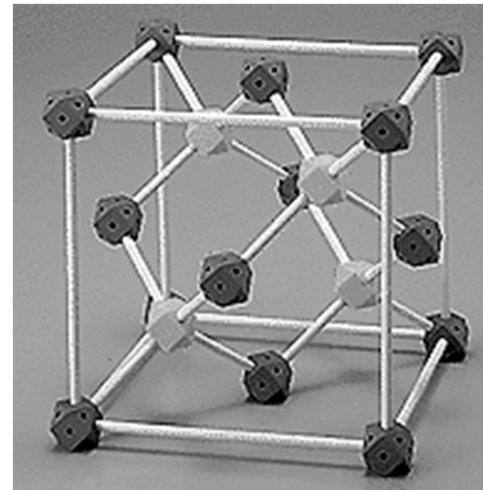



# Simple cubic (SC)

1. Introduction	□□□□□□□□
2. Crystal	□□□□□□□□□□
3. Cubic Lattices	□□□□□□□□
4. Other	□□□□
5. Miller Indices	□□□□□

Example:

alpha polonium

Coordination Number (# of nearest nbs.) =

# of atoms/cell =

Packing fraction =

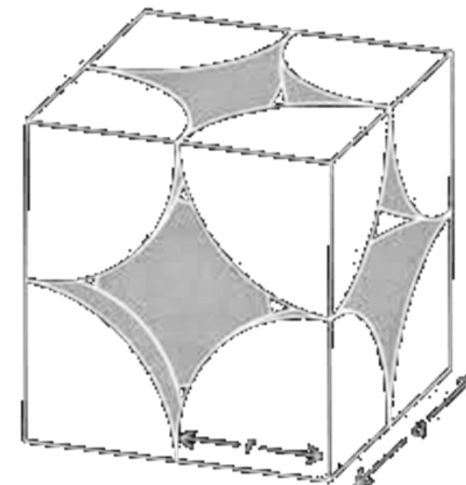
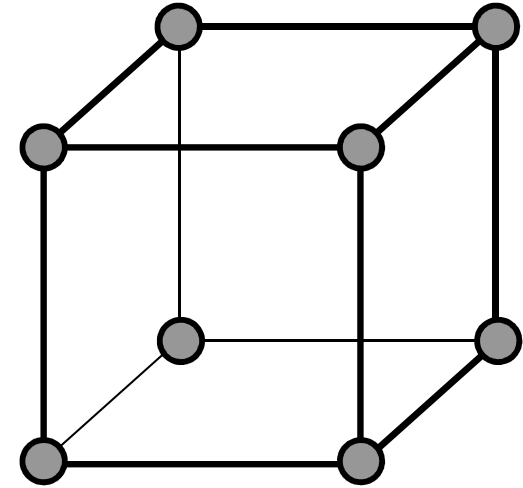

# Body-centered cubic (BCC)

1. Introduction	□□□□□□□□
2. Crystal	□□□□□□□□□□
3. Cubic Lattices	□□□□□□
4. Other	□□□□
5. Miller Indices	□□□□□

Example:  
Sodium,



Molybdenum,



Tungsten

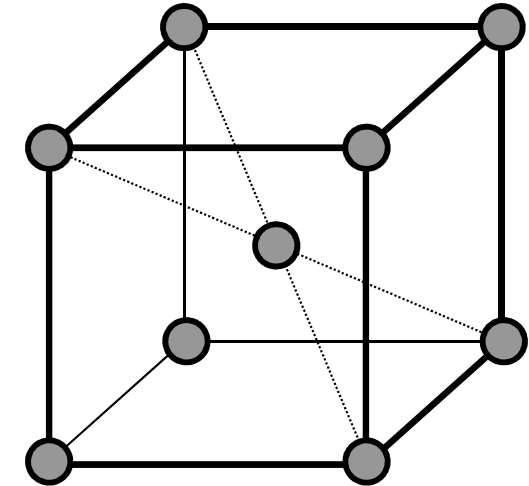

Coordination Number (# of nearest nbs.) =  
# of atoms/cell =  
Packing fraction =

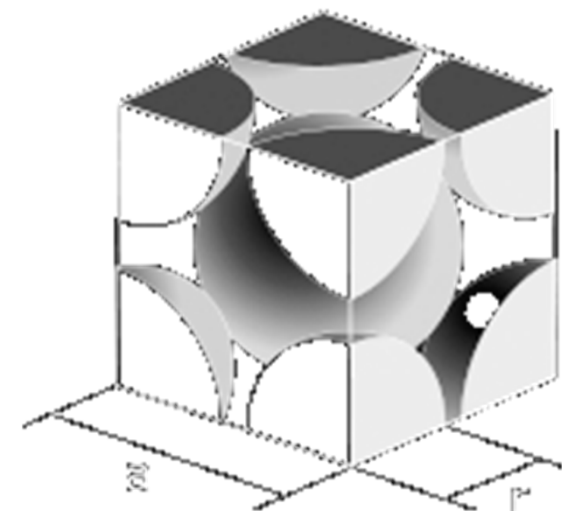

# Face centered cubic (FCC)

1. Introduction	□□□□□□□□
2. Crystal	□□□□□□□□□□
3. Cubic Lattices	□□□□□□□□
4. Other	□□□□
5. Miller Indices	□□□□□

Example:  
Aluminum,



Copper,



Gold,



Silver,

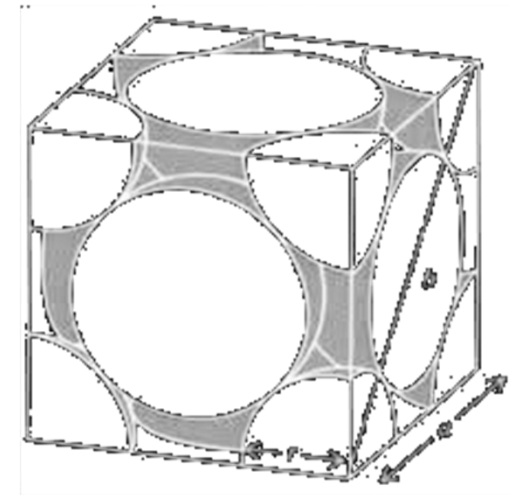
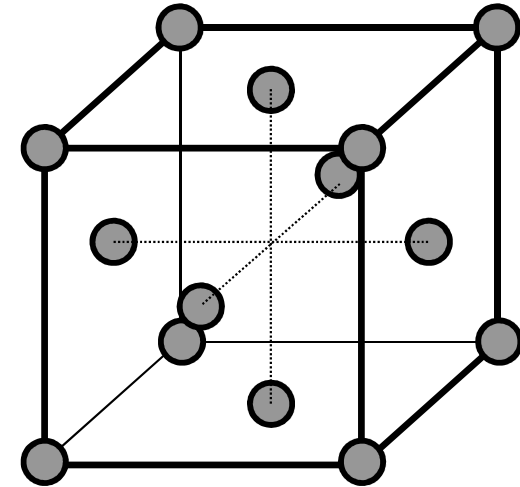

Coordination Number (# of nearest nbs.) =  
# of atoms/cell =  
Packing fraction =

# Diamond Lattice

1. Introduction	<input type="checkbox"/>
2. Crystal	<input type="checkbox"/>
3. Cubic Lattices	<input type="checkbox"/>
4. Other	<input type="checkbox"/>
5. Miller Indices	<input type="checkbox"/>

Example:  
Silicon, Germanium, Carbon

Coordination Number (# of nearest nbs.) =  
# of atoms/cell =  
Packing fraction =

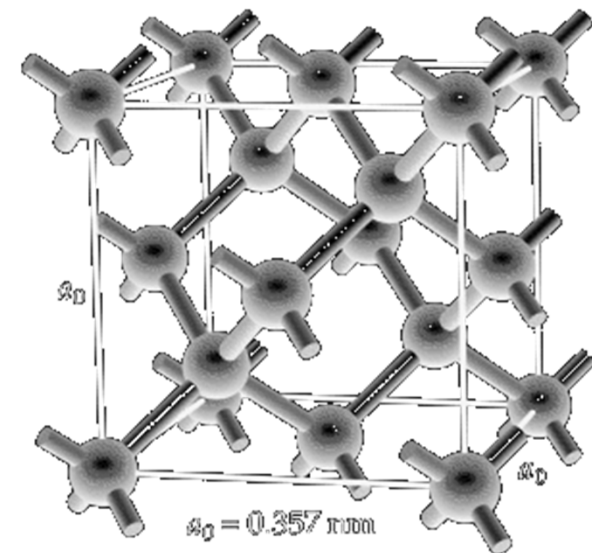
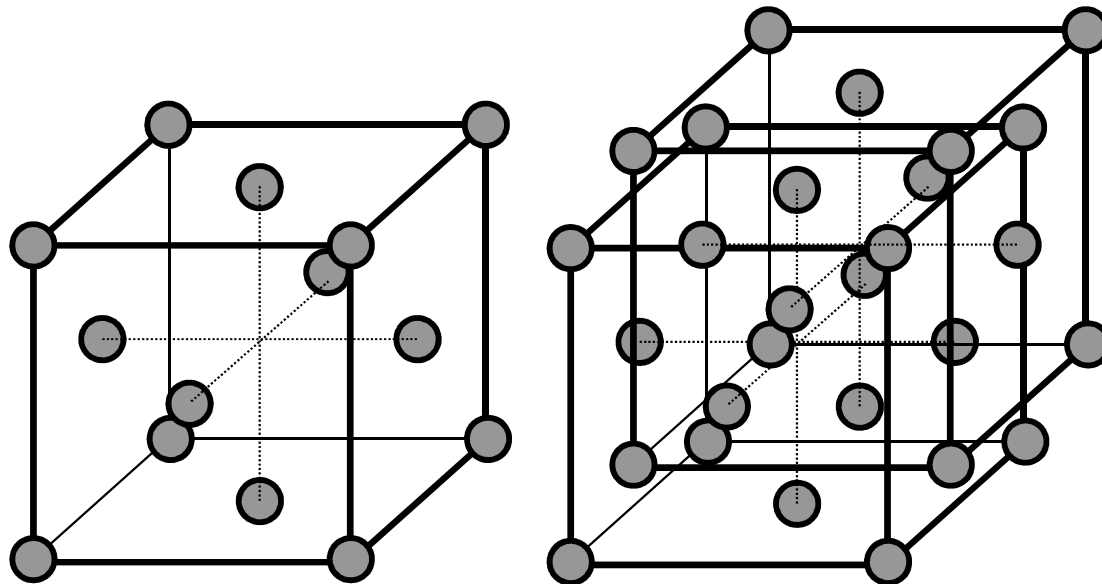
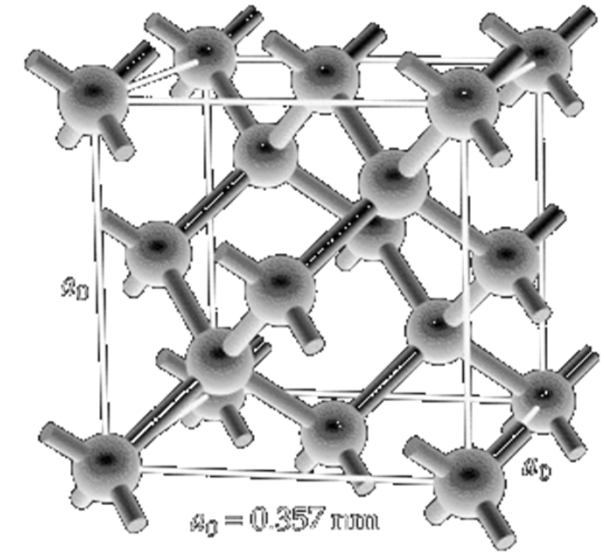

# Diamond Lattice

1. Introduction	□□□□□□□□
2. Crystal	□□□□□□□□□□
3. Cubic Lattices	□□□□□□□
4. Other	□□□□
5. Miller Indices	□□□□□

Example:

Silicon, Germanium, Carbon

Coordination Number (# of nearest nbs.) =

# of atoms/cell =

Packing fraction =

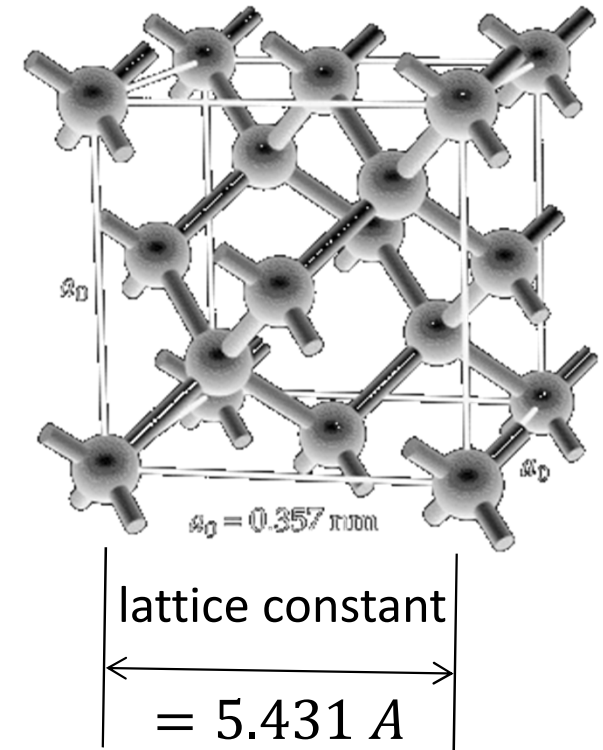

cell volume:

$$(0.543 \text{ nm})^3 = 1.6 \times 10^{-22} \text{ cm}^3$$

Density of silicon atoms

$$= (8 \text{ atoms}) / (\text{cell volume}) = 5 \times 10^{22} \text{ atoms/cm}^3$$

# Zinc Blende Structure

1. Introduction	□□□□□□□□
2. Crystal	□□□□□□□□□□
3. Cubic Lattices	□□□□□□
4. Other	□□□□
5. Miller Indices	□□□□□

III-V semiconductors, important for optoelectronics.

GaAs, InP,  
InGaAs,  
InGaAsP,.....

For GaAs:  
Each Ga surrounded By 4 As,  
Each As Surrounded by 4 Ga

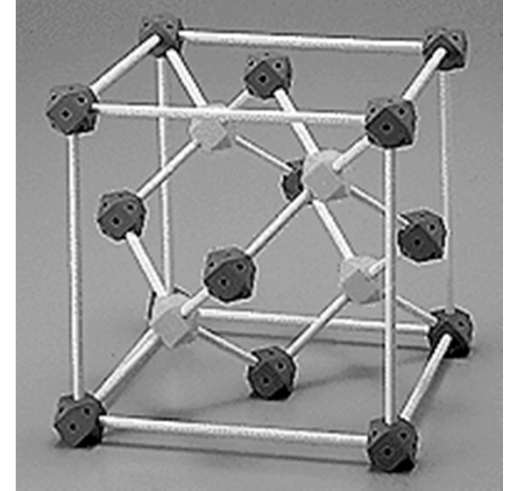

# Symmetry

1. Introduction	<input type="checkbox"/>
2. Crystal	<input type="checkbox"/>
3. Cubic Lattices	<input type="checkbox"/>
4. Other	<input type="checkbox"/>
5. Miller Indices	<input type="checkbox"/>

Many physical properties depends on the symmetry

n- fold rotational symmetry

$$C_n: 2\pi/n \text{ rotation } (n = 1,2,3,4,6)$$

Inversion center symmetry

$$I: r \mapsto -r \quad \text{no center symmetry} \rightarrow \text{piezoelectricity}$$

plane of symmetry (reflection)

$$\sigma$$

rotation – inversion symmetry

$$S_n: C_n + \sigma$$

# Symmetry

1. Introduction	<input type="checkbox"/>
2. Crystal	<input type="checkbox"/>
3. Cubic Lattices	<input type="checkbox"/>
4. Other	<input type="checkbox"/>
5. Miller Indices	<input type="checkbox"/>

$C_n$

$n = 2$

$n = 3$

$n = 10$

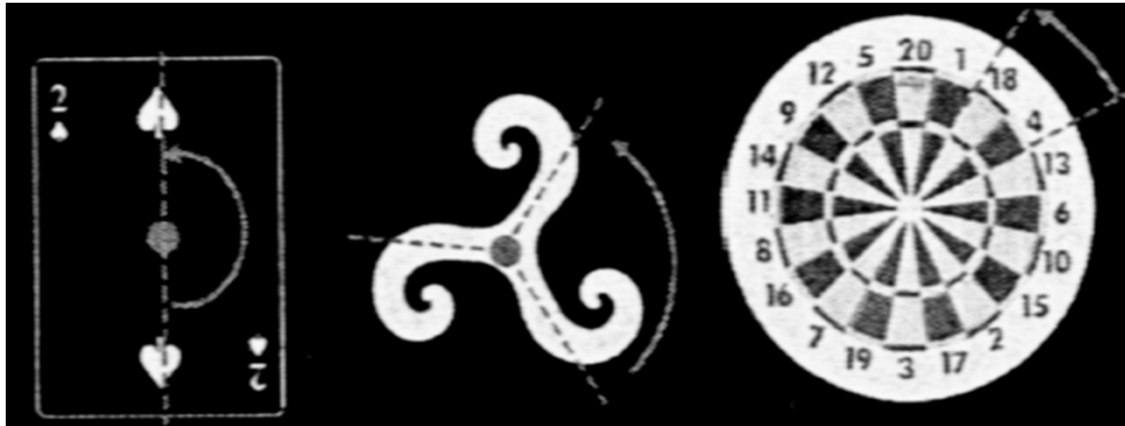

$I: r \mapsto -r$

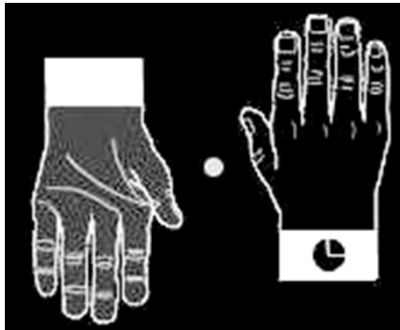

$\sigma$

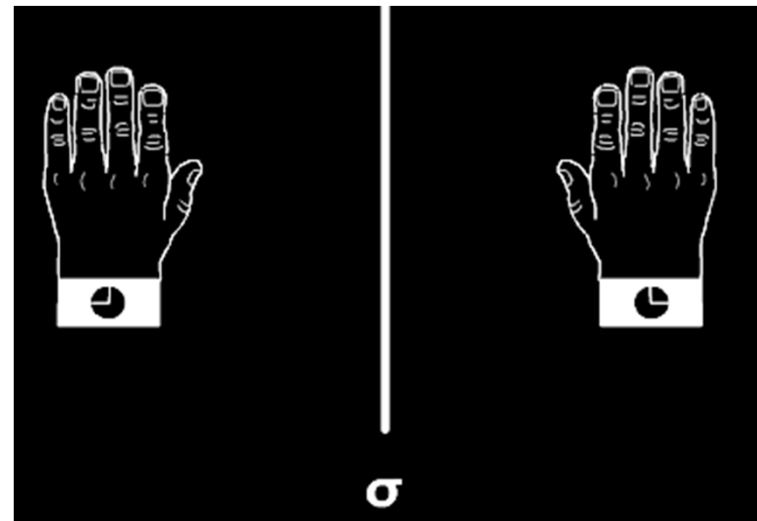



# M. C. Escher

1. Introduction	<input type="checkbox"/>
2. Crystal	<input type="checkbox"/>
3. Cubic Lattices	<input type="checkbox"/>
4. Other	<input type="checkbox"/>
5. Miller Indices	<input type="checkbox"/>

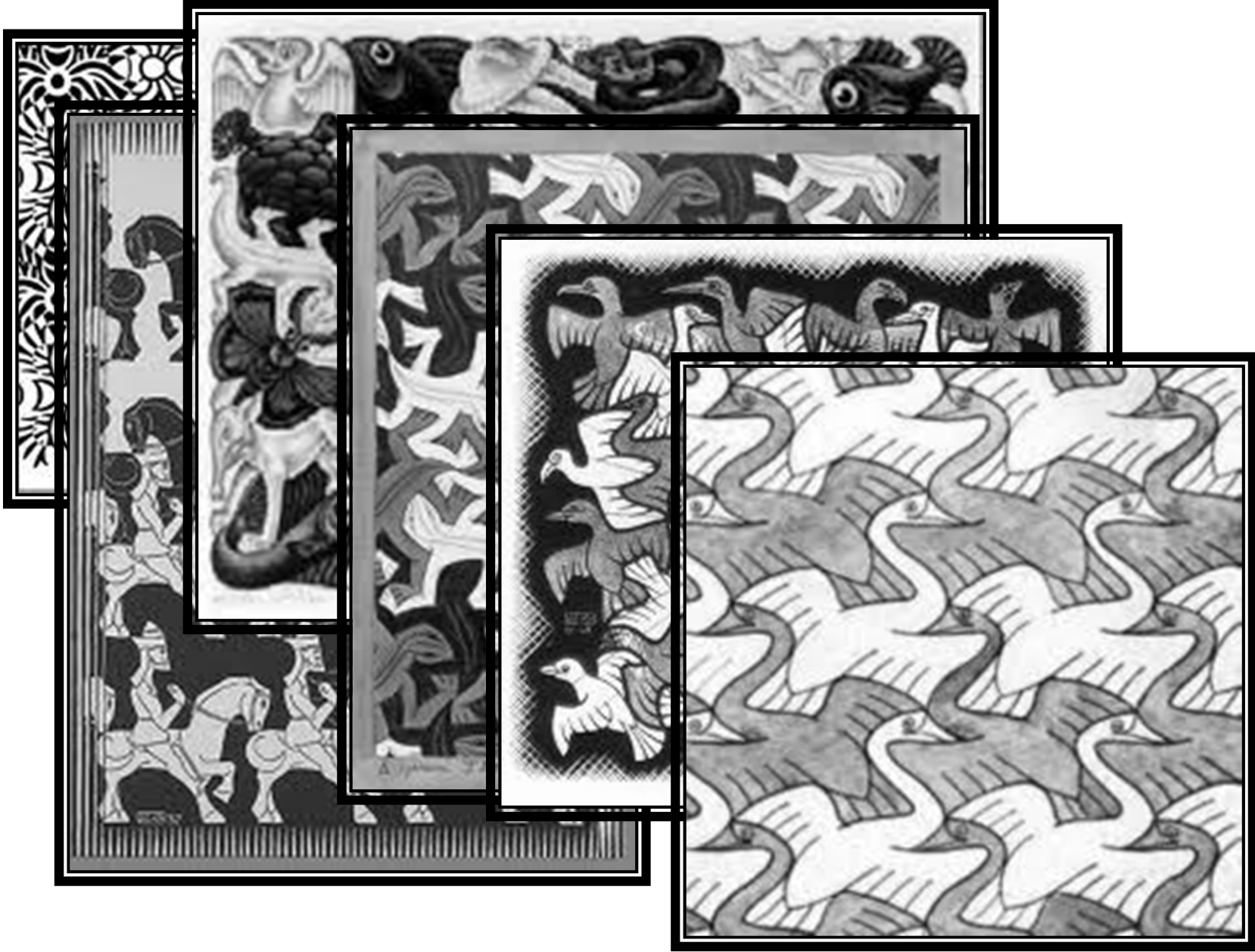

M C Escher  
(1898 – 1972)

# Non-Bravais Lattices

1. Introduction	□□□□□□□□
2. Crystal	□□□□□□□□□□
3. Cubic Lattices	□□□□□□
4. Other	□□□□
5. Miller Indices	□□□□□

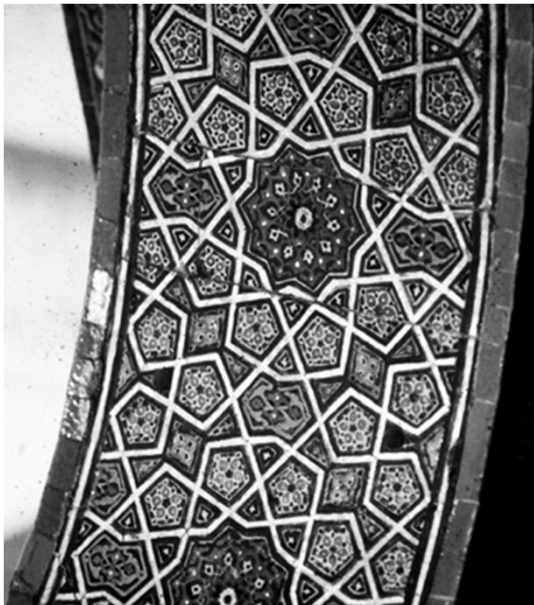
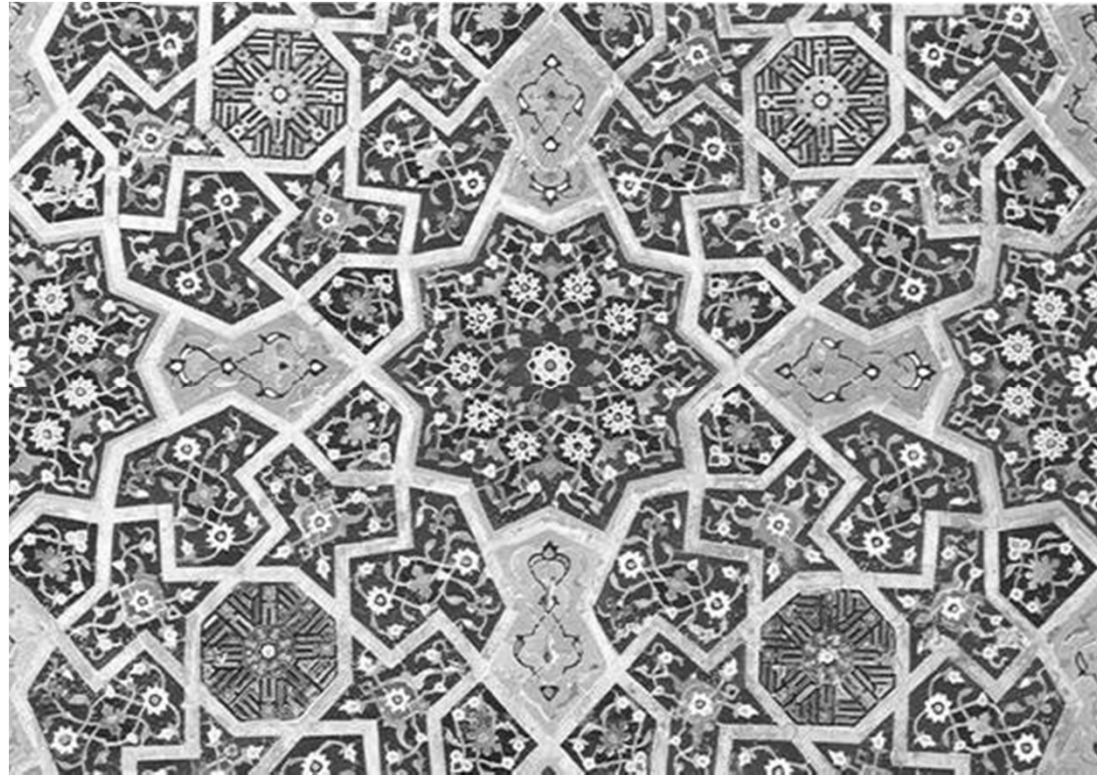
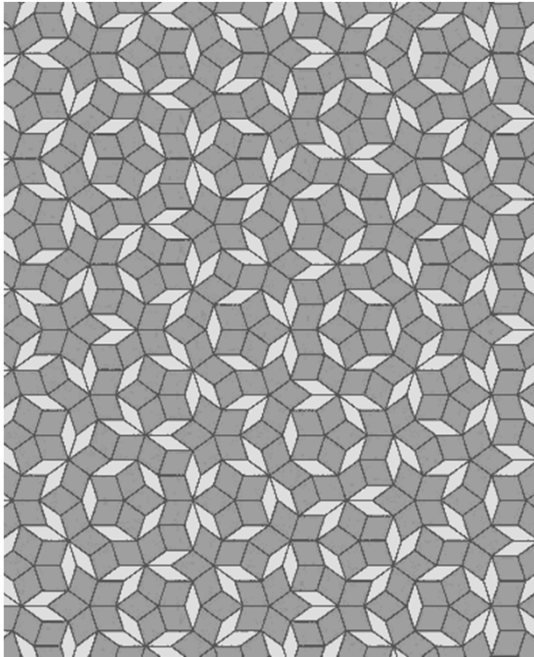

SCIENCE VOL 315 23 FEBRUARY 2007

## Decagonal and Quasi-Crystalline Tilings in Medieval Islamic Architecture

Peter J. Lu<sup>1\*</sup> and Paul J. Steinhardt<sup>2</sup>

<http://www.npr.org/templates/story/story.php?storyId=7544360>  
<http://www.phy.princeton.edu/~steinh/islamictilings.html>

# Miller Indices

1. Introduction	<input type="checkbox"/>
2. Crystal	<input type="checkbox"/>
3. Cubic Lattices	<input type="checkbox"/>
4. Other	<input type="checkbox"/>
5. Miller Indices	<input type="checkbox"/>

A method to label distinct planes and direction within a crystal structure.

steps:

1. Note where the plane to be indexed intercepts the axes (chosen along unit cell directions). Record result as whole numbers of unit cells in the x, y, and z directions, e.g., 2, 1, 3.
2. Take the reciprocals of these numbers, e.g.,  $1/2$ , 1,  $1/3$
3. Convert to whole numbers with lowest possible values by multiplying by an appropriate integer, e.g.,  $\times 6$  gives 3, 6, 2.
4. Enclose number in parentheses to indicate it is a crystal plane categorization, e.g., (3,6,2)

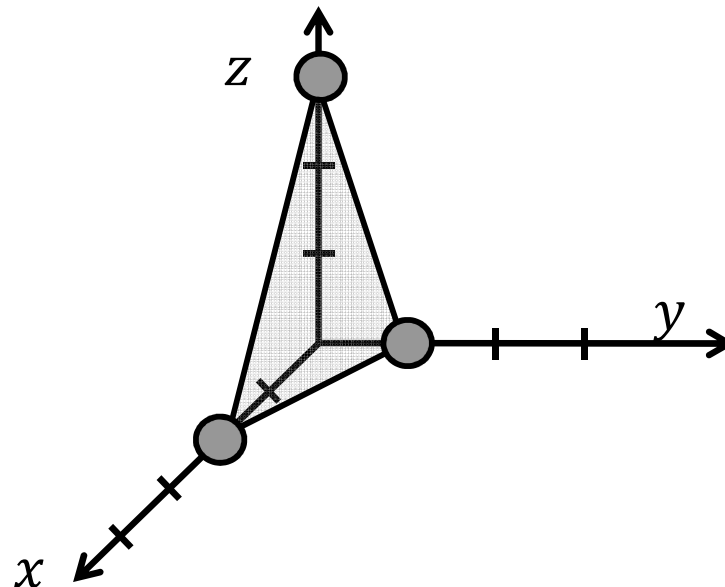

# Miller Indices

1. Introduction	□□□□□□□□
2. Crystal	□□□□□□□□□□
3. Cubic Lattices	□□□□□□
4. Other	□□□□
5. Miller Indices	□□□□□

Planes parallel to a unit cell coordinate axis are viewed as intercepting the axis at infinity, so have an associated Miller index in that direction of zero, e.g., (100) plane. Planes intersecting along the negative axis use a bar over the index rather than a negative sign, e.g.,  $\bar{1}$  rather than  $-1$ , e.g.,  $(1\bar{1}1)$ .

Groups of equivalent planes,  $(100)$ ,  $(010)$ ,  $(001)$ ,  $(\bar{1}00)$ ,  $(0\bar{1}0)$ , and  $(00\bar{1})$  all equivalent because rotation about the 3 fold axes on the cube diagonals maps the various faces into one another, making the planes equivalent) are notated in curly brackets, i.e.,  $\{100\}$  for the above set of equivalent planes.

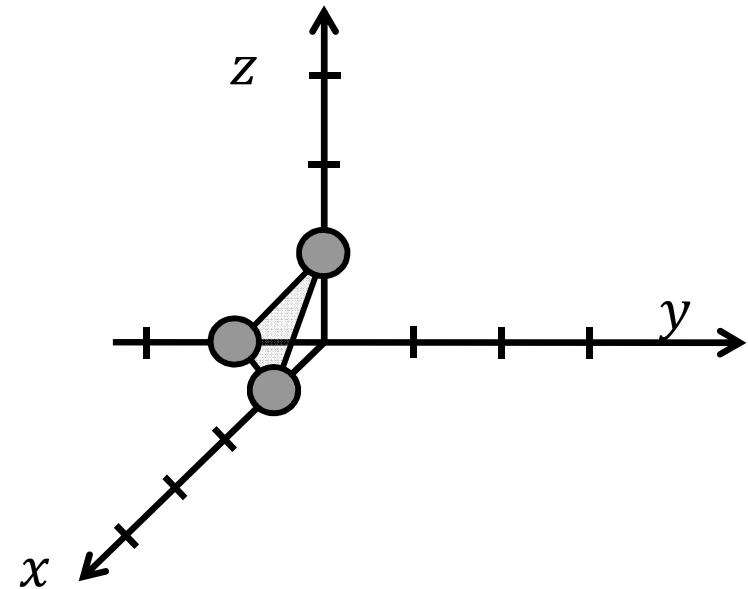
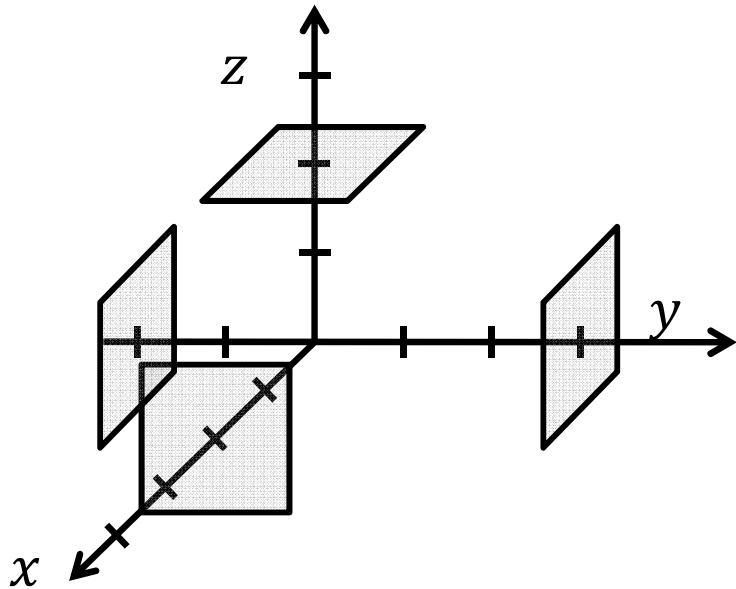

# Miller Indices

1. Introduction	□□□□□□□□
2. Crystal	□□□□□□□□□□
3. Cubic Lattices	□□□□□□
4. Other	□□□□
5. Miller Indices	□□□□■

Similar procedure can be used to define Miller indices for directions.

1. Set up a vector of arbitrary length in the direction of interest (must be a crystal direction, i.e., connecting two crystal points)
2. Decompose the vector into its basis vector components in the a, b, and c directions
3. Convert the resulting numbers to the lowest possible set of integers by multiplying by an appropriate number

Directions are notated using square brackets, e.g.,  $[1\bar{1}1]$

For cubic crystals, directions perpendicular to particular crystal planes can be indexed using the same index as the plane. Sets of equivalent directions are specified by triangular brackets, e.g.,  $\langle 100 \rangle$

$$[h, k, l] \perp (h, k, l)$$

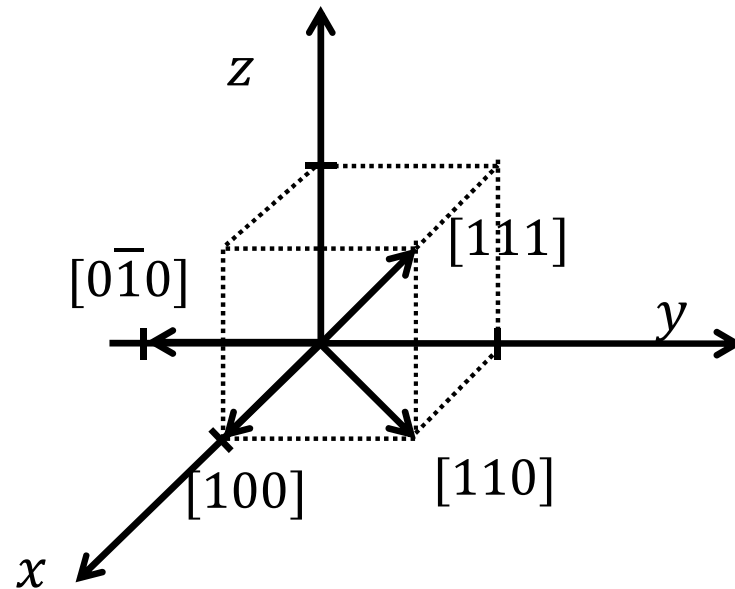

# Miller Convention Summary

1. Introduction	<input type="checkbox"/>
2. Crystal	<input type="checkbox"/>
3. Cubic Lattices	<input type="checkbox"/>
4. Other	<input type="checkbox"/>
5. Miller Indices	<input type="checkbox"/>

Convention	Interpretation
$(hkl)$	Crystal plane
$\{hkl\}$	Equivalent planes
$[hkl]$	Crystal direction
$\langle hkl \rangle$	Equivalent directions

# Crystallographic Planes

1. Introduction	<input type="checkbox"/>
2. Crystal	<input type="checkbox"/>
3. Cubic Lattices	<input type="checkbox"/>
4. Other	<input type="checkbox"/>
5. Miller Indices	<input type="checkbox"/>

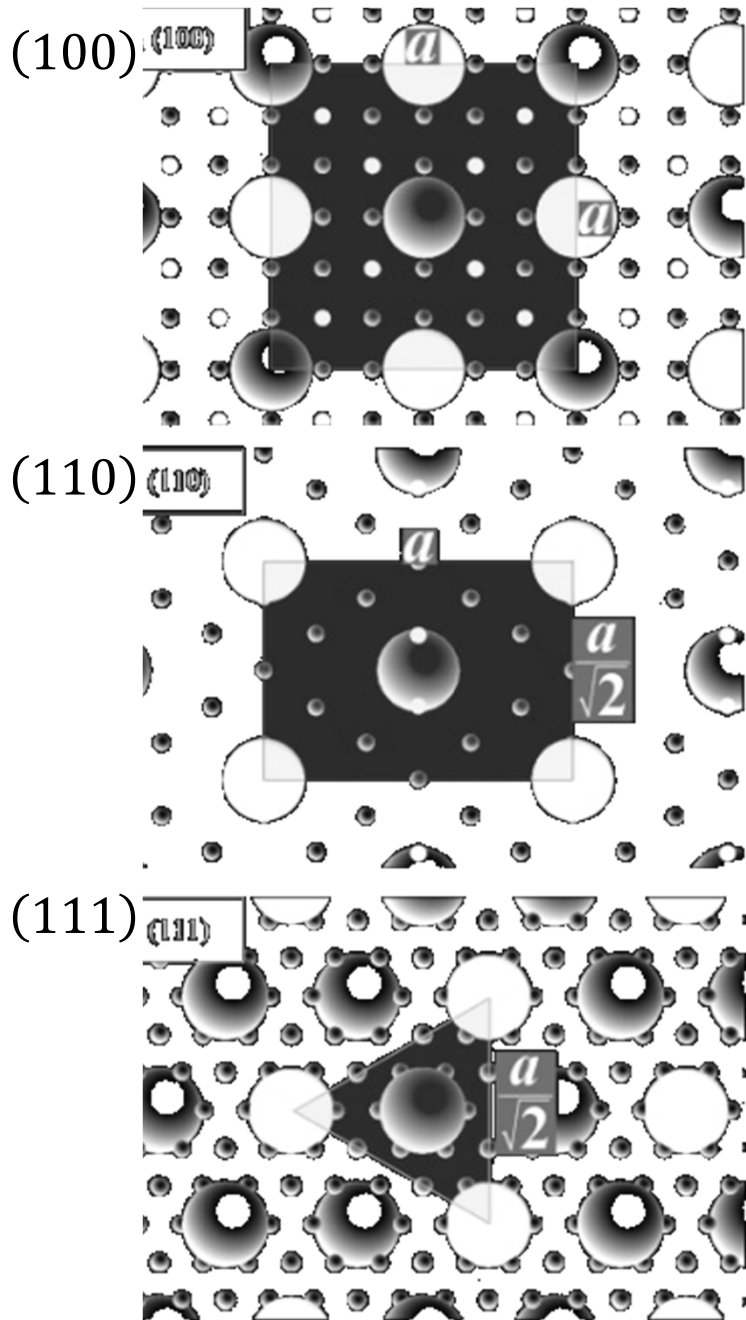

Silicon wafers are usually cut along the (100) plane with a flat or notch to help orient the wafer during IC fabrication.

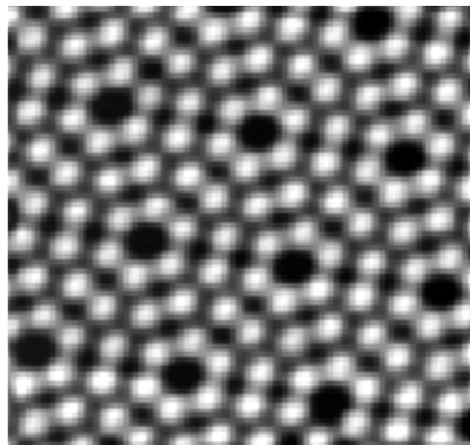
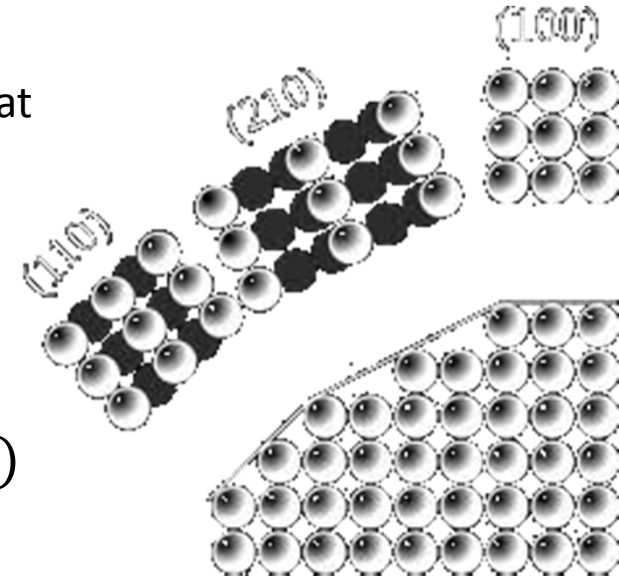
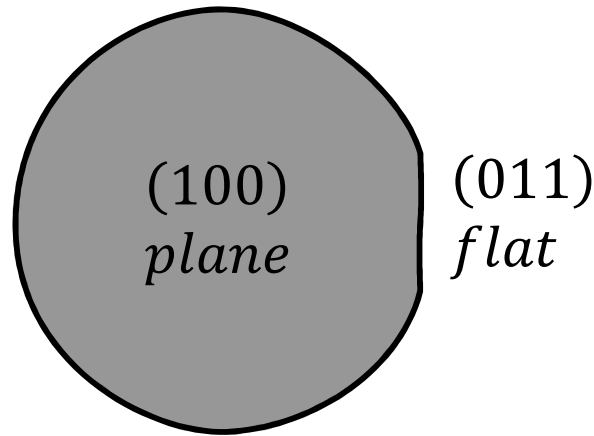

(111) view